

A Modular, Low Latency, A²B-based Architecture for Distributed Multichannel Full-Digital Audio Systems

Nicholas Rocchi
Dept. of Engineering and Architecture
University of Parma
Parma, Italy
nicholas.rocchi@unipr.it

Andrea Toscani
Dept. of Engineering and Architecture
University of Parma
Parma, Italy
andrea.toscani@unipr.it

Daniel Pinardi
Dept. of Engineering and Architecture
University of Parma
Parma, Italy
daniel.pinardi@unipr.it

Marco Binelli
Dept. of Engineering and Architecture
University of Parma
Parma, Italy
marco.binelli@unipr.it

Lorenzo Chiesi
Dept. of Engineering and Architecture
University of Parma
Parma, Italy
lorenzo.chiesi@gmail.com

Angelo Farina
Dept. of Engineering and Architecture
University of Parma
Parma, Italy
angelo.farina@unipr.it

Elia Bonomi
Dept. of Architecture
University of Bologna
Bologna, Italy
eliabonomi@yahoo.it

Lamberto Tronchin
Dept. of Architecture
University of Bologna
Bologna, Italy
lamberto.tronchin@unibo.it

Abstract—Despite the increasing demand for multichannel audio systems, existing solutions are still mainly analog or audio-over-IP based, leading to well-known limitations: bulky wiring, high latency (0.5–2 ms), and expensive devices for protocol stack management. This paper presents a cost-effective, low latency, full-digital solution that overcomes all the previously mentioned problems. The proposed architecture is based on the new Automotive Audio Bus (A²B) protocol. It guarantees deterministic latency of 2 samples, 32 downstream/upstream channels over a single Unshielded Twisted Pair (UTP) cable and phase-aligned signals. A single A²B chip is required for each node, reducing dramatically the system cost. The developed architecture is composed by a main board and an A²B network. The main board handles up to 64 channels, and it converts standard protocols usually employed for audio signal delivery, such as AES10, AVB and AES67, into A²B streams and vice versa. The A²B network can include a series of devices, for instance power amplifiers, codecs, DSPs, and transducers. There are many application examples including, but not limited to, transducer arrays (e.g., microphone, loudspeaker, accelerometer arrays), audio distribution in meeting rooms, Wave Field Synthesis (WFS), Ambisonics immersive audio systems and Active Noise Control (ANC). A modular and portable WFS system was developed employing the above-described architecture. It is based on eight channels soundbars, which can be daisy-chained in reconfigurable geometries and featuring up to 192 channels.

Keywords—A²B bus, AES10, Ambisonics, AVB, class-D amplifier, spatial audio, WFS

I. INTRODUCTION

A growing interest in 3D audio and massive multichannel systems is currently observed for a variety of applications, ranging from enhanced teleconferencing [1], virtual reality systems [2], or automotive industry [3], [4]. In many cases, spatial audio is recorded and played back with microphone and loudspeaker arrays [5], [6]. Efforts are being made to increase the number of transducers in these systems, for improving the spatial accuracy of microphone arrays and to enlarge the sweet spot of the listening rooms. This, on the other hand, requires an increase in the number of channels, which results in complex and cumbersome wiring and considerable electronics costs. Latest professional audio systems use mainly audio-over-IP (layer 3) solutions to transport audio signals, such as DanteTM [7], [8], Ravenna [9]

and AES67 or possibly audio-over-ethernet protocols (e.g., AVB) [10], [11]. Older implementations working at lower level like AES10 (also known as MADI) are still common [12], whilst few uses analog signal distribution [13]. All these technologies need expensive devices, namely Field Programmable Gate Array (FPGA) or ARM-based processors, to manage the protocol stacks. In addition, audio-over-IP or ethernet protocols introduce typically 0.5-2 ms of latency which is not negligible and even not acceptable in some applications (i.e., Active Noise Control).

In this paper, authors propose a modular, low latency, and low-cost architecture for distributed multichannel systems, based on the recent Automotive Audio Bus (A²B) [14], [15]. A²B is a technology developed by Analog Devices in the last years, which offers features to solve the problems previously mentioned in multichannel audio distribution systems. It is a digital bus capable of transporting up to 32 audio channels in each direction, and command data over distance (up to 40 m) on a single Unshielded Twisted Pair (UTP) cable. The overall cost of the system is reduced thanks to dedicated low-cost transceivers that manage the bus and low-cost cables. Nevertheless, the total latency is deterministic and fixed to 2 samples (e.g., less than 50 μ s at 48 kHz).

In the proposed architecture, A²B is employed to exchange data with the front-end devices, whilst other audio protocols are used to communicate with the central unit, since a single A²B network is limited to 40 m of cable length. In addition, several A²B networks are employed together to exceed the limit of 32 channels. For these purposes, a custom board called A²B-DSP is employed to convert multiple A²B streams into the most common audio protocols [16]. Besides multichannel audio distribution systems, such architecture can bring advantages also in industrial or civil monitoring systems (i.e., vibration analysis). In fact, it is suited to synchronously acquire sensor networks, reducing the number of analog-to-digital conversions and keeping low the system cost.

The paper is organized as follow. Section II provides a brief technical description of the A²B protocol. In section III the proposed architecture and the custom board A²B-DSP are explained. Finally, in the last section of the paper, a full-digital Wave Field Synthesis (WFS) system [17] is presented as a case application of the developed technology.

It features three A²B-DSP boards for delivering up to 192 channels through six A²B networks and 24 soundbars of 8 channels each. Thus, each A²B network comprises four soundbars, which are provided with an integrated 8-ch A²B digital amplifier specifically designed and built.

II. A²B BUS

A²B is a technology developed by Analog Devices in the last years to satisfy the new requirements of the automotive field. It is a digital audio bus, which can transport multi-channel audio as well as control data and power (up to 2.7 W) over a single UTP cable [18]. A²B is based on a daisy-chain topology consisting of a single master and up to 10 slave nodes. The maximum bandwidth of the bus is 50 Mbit/s, allowing to transport up to 32 channels. The supported sample rates are 44.1 kHz and 48 kHz, and the channel widths are 12, 16, 24 and 32 bits. The maximum length of the cabling is 40 m, with up to 15 m between two consecutive nodes. The access to the bus is made possible by an A²B transceiver (AD242x chip family).

An A²B network can be seen in Fig. 1. The red box represents the master board, which comprises an audio host, a target processor and an A²B transceiver. Audio host and target processor can be the same device. The audio host manages audio data flow and communicates with the A²B transceiver through Inter-Integrated Circuit Sound (I²S) or Time Division Multiplexing (TDM). The target processor is typically a microcontroller, and it is needed to configure the network at the start-up of the system. The A²B transceiver, once configured by the target processor, manages the communication over the bus and passes audio data and Inter-Integrated Circuit (I²C) commands between the bus and the audio host and target processor. Blue boxes in Fig. 1 represent slave boards. They can be equipped with several devices depending on the application, but they must have an A²B transceiver, which receives data on the bus from the previous node and it transmits them to the next node. A slave transceiver offers an additional Pulse Density Modulation (PDM) interface to communicate, for example, with Micro Electro-Mechanical System (MEMS) transducers, such as microphones and accelerometers.

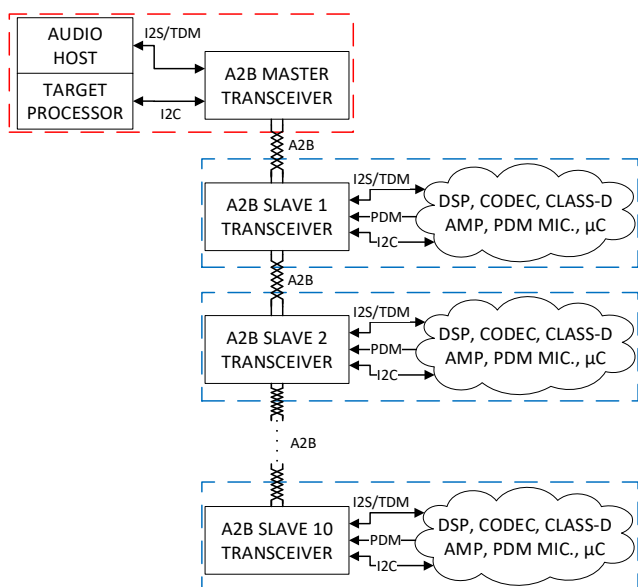

Fig. 1. Architecture of an A²B network composed by a master node and up to ten slave nodes.

A²B network configuration is the only task that is not managed by the transceiver. The configuration process is carried out by the target processor and consists of two phases: discovery and initialization. During the discovery, the target processor searches for new nodes on the bus and initializes them. The main parameters of the transceiver to be configured are I/O ports configuration, I²S/TDM or PDM format settings and channel slots to add or use. The target processor not only configures the A²B slave transceiver, but it can also initialize its peripherals. Once this first task is finished, audio data flow starts, and the target processor is not required anymore except for optional diagnostic. Usually, in the automotive applications for which the A²B technology has been developed, the network is permanent: once the system is installed, the number of nodes, their order, the number of channels, and the routing do not change. In these cases, the target processor knows from the start the characteristics of the network and successfully configure it at the power on. This feature is not particularly suited for non-automotive applications, such as professional or consumer audio distribution systems, where the topology of the network, the number of devices, or the channel routing may change frequently depending on the context. In addition, users may need to add or remove devices or even change the channel routing whilst the network is working. Since standard A²B does not allow reconfiguring the network dynamically, the authors have developed application-level solutions to make A²B a plug-and-play protocol. These features will be formalized in a future work.

During the normal operation, the audio host feeds the A²B master transceiver with the frame synch clock, whose frequency is equal to the sampling frequency, to synchronize all the nodes. Communication over the bus consists of a downstream phase and an upstream phase. The downstream is the communication flow from the master toward the last slave node, whilst the upstream starts from the last slave and ends to the master node. The duration of these two phases is one sample time. This feature guarantees a completely deterministic latency of 2 samples (less than 50 μs at 48 kHz), independent from the position of the node in the bus.

Data transmission over the A²B bus happens by means of a packet called superframe (Fig. 2). The superframe is composed by one header and one payload for each of the two phases (downstream and upstream). The header consists of a preamble used for the node's Phase-Locked Loop (PLL) synchronization and I²C commands. The downstream and upstream headers are called Synch Control Frame (SCF) and Synch Response Frame (SRF), respectively. Each header is followed by a payload containing one audio sample for each channel. When an A²B transceiver receives the superframe, it can consume audio slots or add data for the next nodes (downstream) or for the previous nodes (upstream).

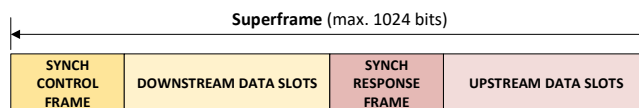

Fig. 2. Structure of the A²B superframe.

If the required number of channels is greater than 32, up to four A²B networks can be combined to increase the system capabilities up to 128 channels, exploiting the availability of four I²C addresses in the A²B master transceiver. Since the devices of a single network are synchronized by the clock fed to the master node, no synchronization issues arise if the same clock is fed to all the A²B networks. It shall be pointed out that

the A²B transceivers are not able to route audio samples between two different networks. Thus, this connection must be implemented at audio host level.

III. SYSTEM ARCHITECTURE

The proposed system architecture is a cost-effective, low latency, full-digital solution designed to improve today's multi-channel distribution systems. Fig. 3 shows the block diagram of the system architecture, which is composed by three main parts: a commercial audio system (i.e., a PC, a mixer, or an audio interface), a conversion and processing board, namely A²B-DSP in Fig. 3, and several A²B networks.

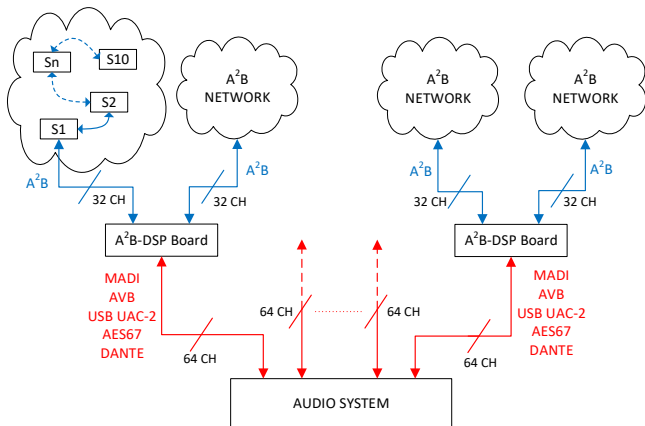

Fig. 3. Block diagram of the proposed system architecture.

The key part of the whole architecture is the A²B-DSP board. The principal task of the A²B-DSP board is the format conversion between A²B and the most used audio protocols, which should be chosen depending on the existing audio system and the number of channels required. The board is equipped with the main multichannel audio interface standards (see Fig. 4 and Fig. 5): a gigabit ethernet interface, employed as an AVB endpoint and for control and DSPs programming, an USB 2.0 providing an UAC2 compliant interface, a coaxial BNC and optical transceivers to implement an AES10 connection. In addition, an expansion connector allows to attach a commercial or custom daughterboard to interface with other common audio format like AES67 or DanteTM. Other auxiliary interfaces are present on the board to maximize the system interoperability and to provide additional utilities to the user: one AES3/SPDIF input and one output, a microphone input, a line input and output and a headphones output.

On the other side, the board provides the connection to A²B networks, which can be composed by many kinds of devices: digital amplifiers, transducers, processing units, Digital-to-Analog converters (DAC) or Analog-to-Digital converters (ADC). These devices communicate over the A²B bus through transceivers that act as slave nodes (represented by blocks S1 to S10 in Fig. 3). To overcome the 32 channels limit of the A²B bus, each A²B-DSP board offers the connection to two A²B networks, reaching a 64 channels capability in each direction.

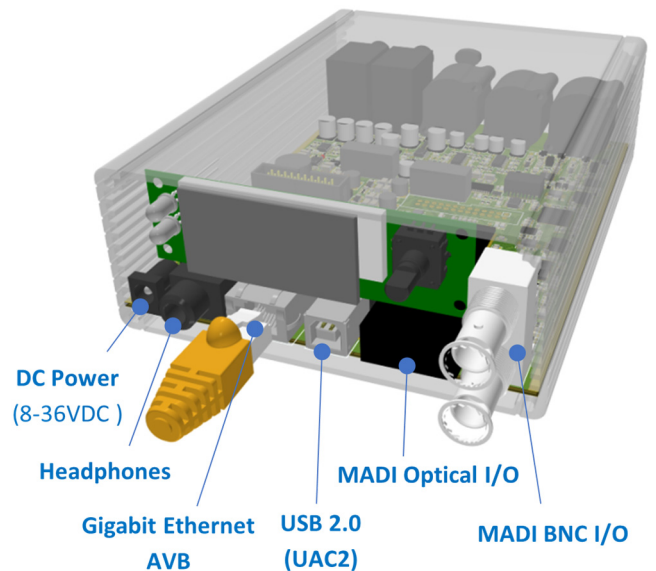

Fig. 4. Input/output connectivity of the A²B-DSP board, front view.

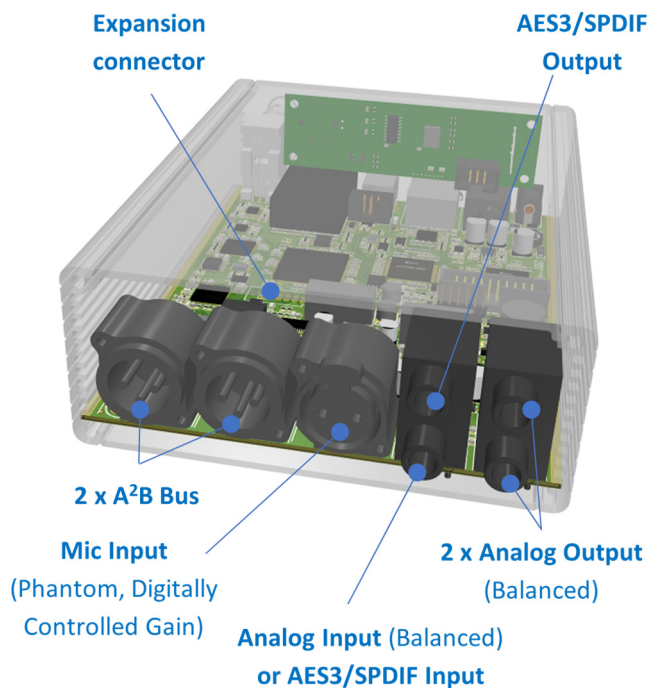

Fig. 5. Input/output connectivity of A²B-DSP board, rear view.

Another key point of the system is the modularity. In fact, it is possible to connect several A²B-DSP boards to the audio system to increase the maximum channel capability (as shown in Fig. 3). In addition, the presence of many audio protocols with different distance ranges makes the A²B-DSP board suitable for different applications, such as monitoring systems or massive multichannel audio systems. In the first case, a limited number of sensors are positioned at a great distance from each other, while in the second case a high number of transducers (e.g., loudspeakers) are located relatively close.

Besides the conversion among audio transmission formats, the second task of the board is the signal processing. The board embeds two DSPs, which are programmable with a visual development environment (SigmaStudio®) directly through ethernet port. Each DSP is capable to compute up to 24000 taps at 48 kHz, allowing to reduce the computational power required by the control unit. Such filtering capability can be employed in several applications, e.g., room correction or loudspeakers pre-equalization (up to 512 taps per channel,

with 64 channels), but also to implement spatial audio algorithms. The DSP also offers the possibility of asynchronous resampling of the signals coming from different digital audio interfaces. This comes to hand to solve common clocking problems in complex audio networks.

A top view of the board is shown in Fig. 6, where principal components are highlighted: XMOS host processors, audio codec, FPGA, DSPs and A²B transceivers. The signal flow of the A²B-DSP board is shown in Fig. 7. One can note the flexible routing of all audio signals thanks to the FPGA, which implements also the AES10 transceiver. Finally, in Fig. 8 one can see a picture of the built prototype of the A²B-DSP board.

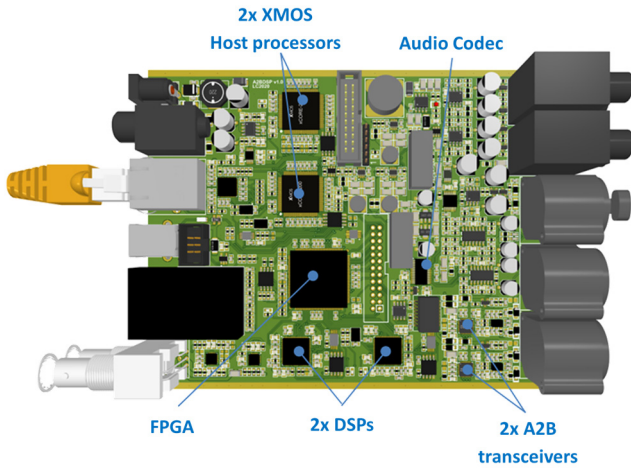

Fig. 6. Main components of the A²B-DSP board, top view.

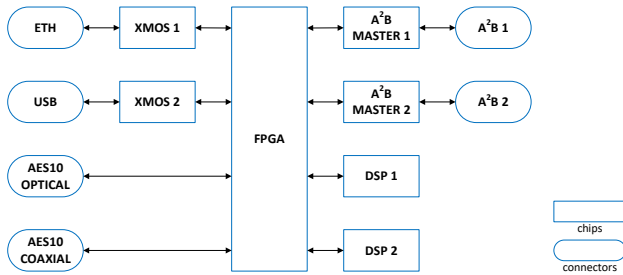

Fig. 7. Audio signal flow on the designed board.



Fig. 8. A picture of the A²B-DSP board prototype.

IV. A CASE APPLICATION: WAVE FIELD SYNTHESIS SYSTEM OVER A²B BUS

As an application example of the abovementioned technology, here a modular, full-digital Wave Field Synthesis (WFS) system [19] based on A²B bus is described. The whole system, whose architecture is shown in Fig. 9, is managed by

a single sound card, a RME MADIFace XT, which supports up to 192 channels at a sampling frequency of 48 kHz. The soundcard is connected to a PC via USB 3.0 and offers three MADIFace output lines, two optical and one coaxial. Each MADIFace line carries 64 channels to an A²B-DSP board, which generates two A²B networks of 32 channels. Each A²B network can support up to four 8-channels active soundbars, which are the essential units of the whole system (Fig. 10). In addition, each A²B-DSP board can drive two line-level output channels for subwoofers.

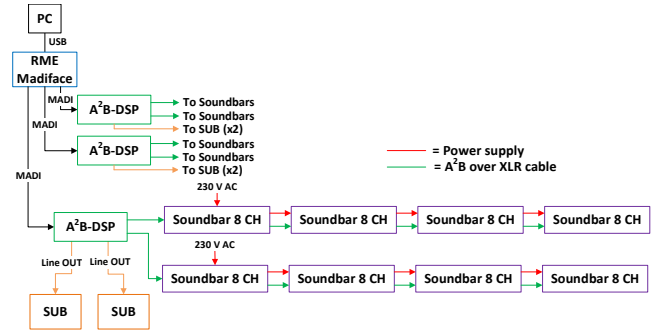

Fig. 9. WFS system architecture.



Fig. 10. The 8-channels sound bar of the Wave Field Synthesis system over A²B.

A soundbar prototype has been built. It is composed by two main parts: a wooden structure, housing the eight loudspeakers, and an aluminum frame for the electronics. The loudspeaker housing is made of birch wood, 12 mm thickness, with dimensions (LxWxH) 100x19x14 cm. Once assembled, the total weight is 10.5 kg. The inter-center distance d of the loudspeakers is 125 mm; thus, the spatial aliasing frequency is about 2.7 kHz on-axis and about 1.8 kHz at 30°, as provided by:

$$f_{alias} = \frac{c}{d \cdot (1 + \sin \alpha)} \quad (1)$$

where $c = 343 \text{ m/s}$ is the speed of sound in air and α is the angle between the direction normal to the sound bar and the listener. Each loudspeaker is mounted in a closed, isolated volume of 1.1 liter (Fig. 11), calculated according to Thiele-Small parameters [20], [21], [22], [23]. For minimizing the standing waves, the rear side is tilted by 10° and each volume is covered in fiberglass on bottom, rear, and top sides. The model of loudspeaker is a 4.0" full range by RCF-group, having nominal impedance 8 ohm, power rating 40 W_{rms}, sensitivity 92 dB SPL (1 W, 1 m).



Fig. 11. WFS soundbar, front view (partial section).

In Fig. 12 (dashed line), it is possible to see the frequency response of the loudspeaker once mounted in the soundbar,

measured in anechoic room at 1 m, 1 W with a calibrated Bruel&Kjaer (B&K) microphone (capsule type 4189, pre-amplifier type 2187). For being more representative, it is shown the measurement relative to the speaker mounted in the center of the soundbar (number 4). Thanks to the two DSPs, whose A²B-DSP board is equipped with, it is possible to introduce an individualized filtering on each channel, employing Finite Impulse Response (FIR) filters. In Fig. 12 (dotted line), one can see the frequency response of an inverse filter calculated with the regularized Kirkeby method [24]. Finally, solid line of Fig. 12 shows the equalized response of the loudspeaker, which results almost flat (± 1 dB) in the frequency range 200 Hz – 11.2 kHz.

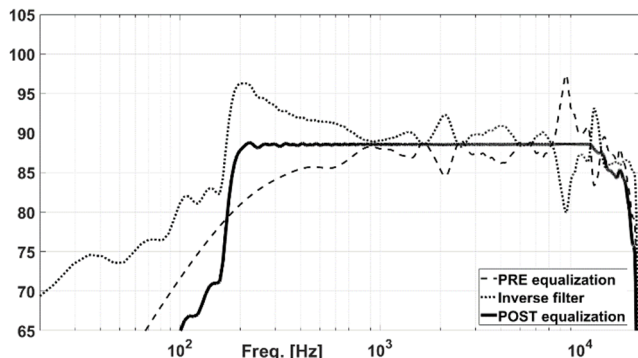

Fig. 12. Frequency responses of a not-equalized loudspeaker mounted on the soundbar (dashed line), a FIR equalization filter (dotted line) and the equalized loudspeaker (solid line).

On the rear side, an aluminum frame (Fig. 13) houses the electronics (Fig. 14): input and output connectors, a fuse, power supply and a custom A²B 8-channels power amplifier. Power supply is a commercial AC/DC switching, rated power 300 W, output voltage 36 V.

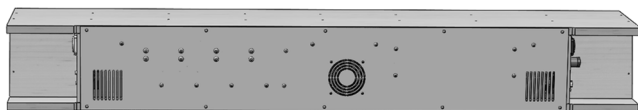

Fig. 13. Electronics housing, rear view.

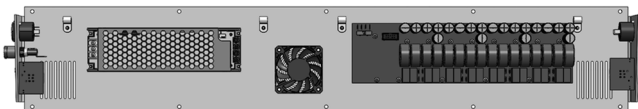

Fig. 14. Electronics housing, top view.

On each side there are two input and two output connectors, one for A²B signal and one for power supply, which are both delivered in daisy chain. Power supply connectors are *powercon*, a standard choice in professional audio application. A²B bus travels between soundbars over AES3 (also known as AES/EBU) digital cables, whose physical specifications are defined in the standard IEC 60958 type 1: shielded twisted pair, 110 ohm, XLR connectors.

The critical element of the soundbars is the A²B full-digital power amplifier (Fig. 15). Each of them comes with four 2-channels class-D amplifier TAS3251 by Texas Instruments, capable to provide 75 W/ch output power on 8 ohm load, when operating at 36 V power supply.

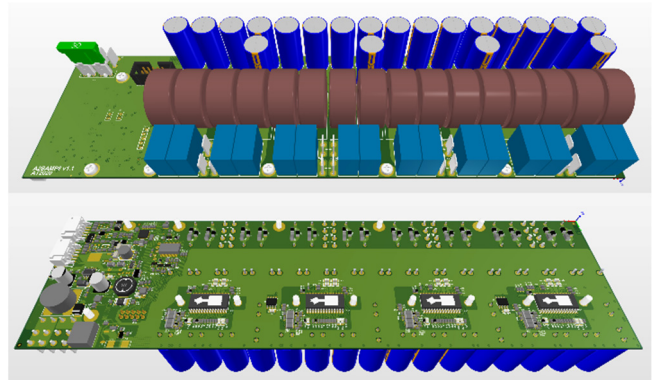

Fig. 15. Designed A2B amplifier board.

The design is daisy chainable: the first power amplifier of the A²B network receives all the 32 channels. It consumes eight channels and passes the remaining. The second one receives 24 channels; it consumes eight channels and passes the remaining and so on. Each class-D amplifier integrates a DSP which provides equalization, crossover, limiter, dynamic range control and volume control for each channel.

The amplifiers are provided with controls for active cooling with a fan. However, with the aim of avoiding the background noise of the fans, chips were mounted with a specially designed support that allows heat transmission over the entire aluminum frame, which acts as a heatsink. Fig. 16 shows the temperature trend measured during four hours of continuous operation at 100 W_{rms}. The temperature is measured on the heatsink near the exposed thermal pad of the amplifier integrated circuit. It reaches a maximum value of 62°C, which is 36 °C above the ambient temperature of 26 °C. Such result allows for a completely passive thermal dissipation under normal ambient and use conditions, avoiding the background noise of the fan. Once reached the steady state, the fan was turned on to evaluate the effectiveness of an active cooling. This resulted in a temperature drop to 42 °C (a reduction of 20 °C) over the next 1.5 hours. A thermal image of the A²B amplifier is shown in Fig. 17. The hottest points are near the power amplifier ICs (Sp1 and Sp2 in Fig. 17).

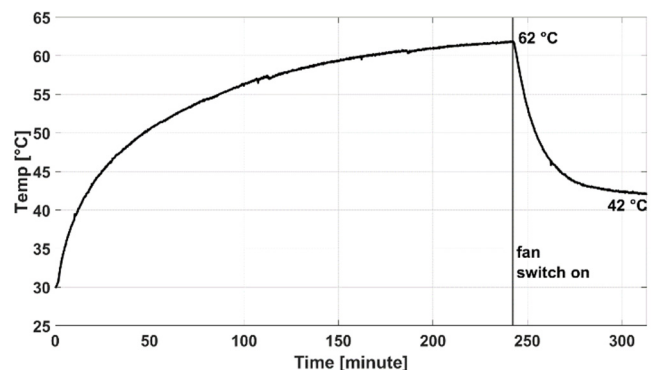

Fig. 16. Temperature trend as a function of time at maximum operating power.

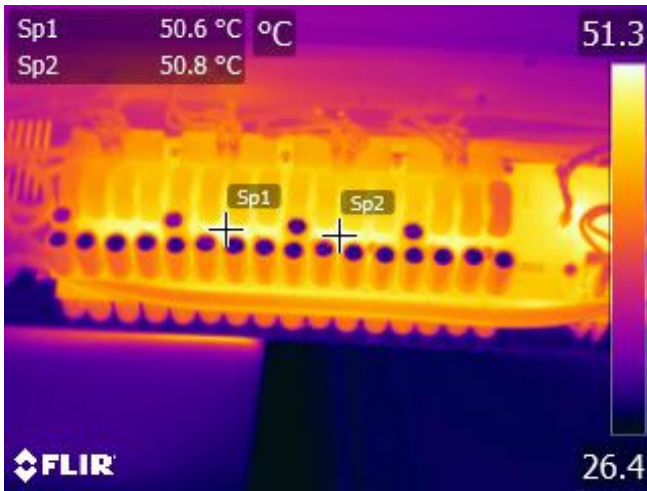

Fig. 17: Thermal image of the amplifier, top view.

The soundbar prototype was measured in an anechoic room at 1 m distance with the previously described B&K microphone, playing a white noise through all the eight loudspeakers active at the same time at maximum power. The recorded SPL is 108 dB.

For characterizing the directivity of the loudspeakers on the horizontal plane, the soundbar was measured on a single-axis turntable (Fig. 18), placing the B&K microphone at 1 m distance. Since the two central loudspeakers are more representative, not being affected by border effects, the soundbar was positioned so that loudspeaker number 4 is aligned with the rotation axis. An Exponential Sine Sweep (ESS) [25] of 10 s covering the range 22 Hz – 22 kHz was played through the loudspeaker for each direction. The measurement was repeated 72 times, with an angular resolution of 5° from 0° to 355°.

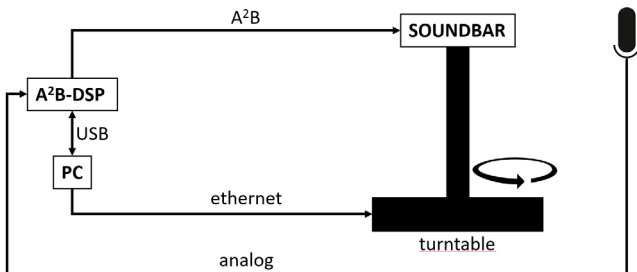

Fig. 18: Experimental setup for directivity measurement.

The deconvolution of the recorded sweeps with the inverse sweep provided the Impulse Responses (IRs). Polar patterns (Fig. 19, Fig. 20) were computed by averaging the directivity in octave bands. Since the DSP's crossover on the loudspeakers is set at 100 Hz, the first two octave bands centered at 31.5 Hz and 63 Hz were not computed. One can note that SPL levels are well matched at all octaves, except for the one centered at 125 Hz, as already seen in Fig. 12.

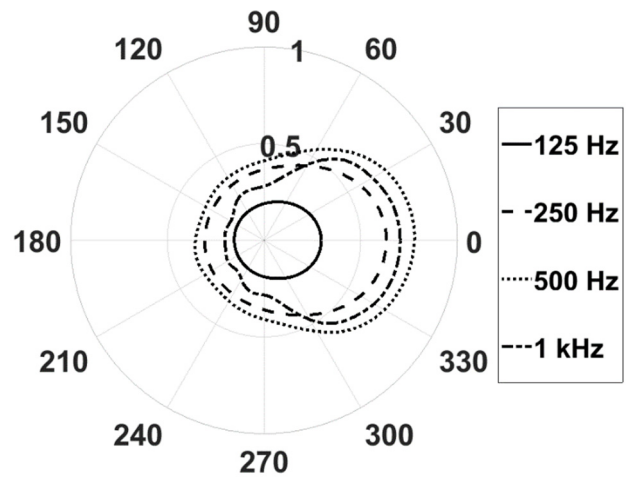

Fig. 19: Polar pattern of the loudspeaker 4 mounted on the soundbar, octave bands 125 Hz, 250 Hz, 500 Hz, and 1 kHz.

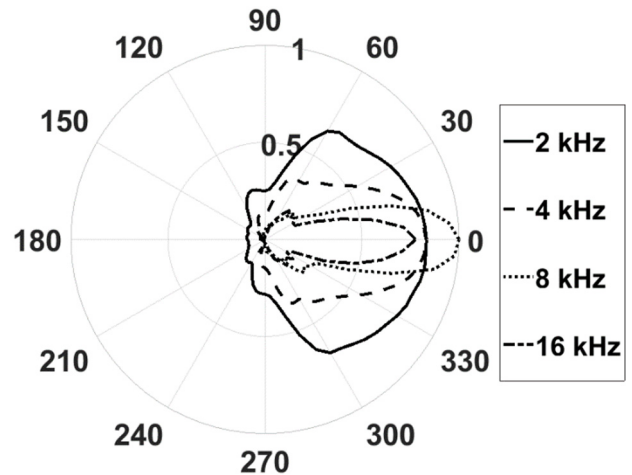

Fig. 20: Polar pattern of the loudspeaker 4 mounted on the soundbar, octave bands 2 kHz, 4 kHz, 8 kHz, and 16 kHz.

In conclusion, Fig. 21 suggests a possible layout with 20 soundbars and 160 channels, which allows for 28 seats, but of course, many others are possible from 64 channels (2x2 m square, 1 seat) up to 192 channels (6x6 m square, 40 seats).

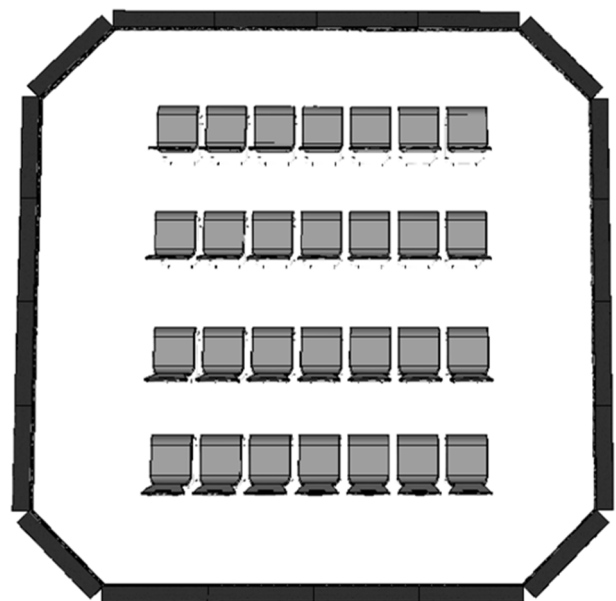

Fig. 21: A suggested layout of a WFS system with 20 soundbars, 160 channel and 28 seats.

V. CONCLUSIONS

The authors proposed an architecture for distributed multichannel systems, with the aim to overcome the traditional limitations related to these systems: flexibility, cost, and performance. The described solution solves efficiently all of them, thanks to the adoption of the recent Automotive Audio Bus.

On one side, it provides significant performance advantages: digital transmission, channels synchronization and very low and deterministic latency. At the same time, the cost of the A²B transceivers and cables is considerably lower with respect to comparable solutions that employ protocols such as MADI, AVB, and audio-over-IP.

The other important contribution consists in the development of an interface board, namely A²B-DSP, which converts the most common audio communication protocols, e.g., MADI and AVB but also USB, into the A²B bus. This provides the mentioned flexibility: the system architecture can be arranged in different ways, depending on the required number of channels and distance to cover. Such characteristic makes the system interesting for a variety of applications, ranging between transducer arrays, industrial and civil monitoring, and Active Noise Control systems for vehicles.

The described architecture was used to develop a cost-effective, full-digital Wave Field Synthesis system featuring 160 channels, composed by three A²B-DSP boards and 20 active soundbars of 8 channels each. The soundbars are provided with 8 channels A²B class-D amplifiers specifically designed. This is the first known MADI-A²B WFS system and can be heard in the municipal room of Faenza city (Ravenna, Italy), where it is being installed.

REFERENCES

- [1] J. Ahonen, V. Pulkki and T. Lokki, "Teleconference Application and B-Format Microphone Array for Directional Audio Coding," in *30th International Conference: Intelligent Audio Environments*, 2007.
- [2] A. A. Kerure and J. Freeman, "Audio Source Localization as an Input to Virtual Reality Environments," in *144th AES Convention*, Atlanta, 2018.
- [3] D. Pinardi, L. Ebri, C. Belicchi, A. Farina and M. Binelli, "Direction Specific Analysis of Psychoacoustics Parameters inside Car Cockpit: A Novel Tool for NVH and Sound Quality," in *SAE Technical Papers*, Graz, 2020.
- [4] A. Farina, D. Pinardi, M. Binelli, M. Ebri and L. Ebri, "Virtual reality for subjective assessment of sound quality in cars," *144th AES Convention*, 2018.
- [5] J. Meyer and G. Elko, "A highly scalable spherical microphone array based on an orthonormal decomposition of the soundfield," *Proc. on IEEE International Conference on Acoustics, Speech and Signal Processing (ICASSP)*, vol. 2, pp. 1781 - 1784, 2002.
- [6] H. Lee, "Multichannel 3D Microphone Arrays: A Review," *Journal of Audio Engineering Society*, vol. 69, no. 1/2, pp. 5-26, 2021.
- [7] S. Kaneko, T. Suenaga, H. Akiyama, Y. Miyake, S. Tominaga, F. Shirakihara and H. Okumura, "Development of a 64-Channel Spherical Microphone Array and a 122-Channel Loudspeaker Array System for 3D Sound Field Capturing and Reproduction Technology Research," in *144th AES Convention*, Milan, 2018.
- [8] M. Pezzoli, L. Comanducci, J. Waltz, A. Agnello, L. Bondi, A. Canciani and A. Sarti, "A Dante™ Powered Modular Microphone Array System," in *AES 145th Convention*, New York, USA, 2018.
- [9] A. Holzinger and A. Hildebrand, "Realtime Linear Audio Distribution Over Networks A Comparison of Layer 2 and 3 Solutions Using the Example of Ethernet AVB and Ravenna," in *AES 44th International Conference*, San Diego, CA, USA, 2011.
- [10] J. Imtiaz, J. Jasperneite and L. Han, "A performance study of Ethernet Audio Video Bridging (AVB) for Industrial Real-time Communication," in *IEEE Conference on Emerging Technologies & Factory Automation*, Pala de Mallorca, Spain, 2009.
- [11] L. Lo Bello, "Novel trends in Automotive Networks: A perspective on Ethernet and the IEEE Audio Video Bridging," in *19th IEEE International Conference on Emerging Technologies and Factory Automation, ETFA 2014*, Barcelona, Spain, 2014.
- [12] T. Reussner, C. Sladeczek, M. Rath, S. Brix, K. Preidl and H. Scheck, "Audio Network-Based Massive Multichannel Loudspeaker System for Flexible Use in Spatial Audio Research," *Journal of Audio Engineering Society*, vol. 61, no. 4, pp. 235-245, 2013.
- [13] "The Game of Life," [Online]. Available: <https://gameoflife.nl/en/>.
- [14] A. Devices, "A2B Audio Bus: an Easier, Simpler Solution for Audio Design," [Online]. Available: <https://www.analog.com/en/applications/technology/a2b-audio-bus.html>.
- [15] M. Kessler, "Introducing the Automotive Audio bus," in *AES Conference on Automotive Audio*, Burlingame, San Francisco, 2017.
- [16] M. Binelli, L. Chiesi, D. Pinardi, N. Rocchi and A. Toscani, "ZotAudio," [Online]. Available: <https://www.zotaudio.it/>.
- [17] J. Ahrens, R. Rabenstein and S. Spors, "The Theory of Wave Field Synthesis Revisited," in *124th AES Convention*, 2008.
- [18] J. Triggs, "The A to Z of A2B Applications," *Analog Dialogue*, vol. 54, no. 3, pp. 1-4, 2020.
- [19] M. M. Boone, E. N. G. Verheijen and P. F. van Tol, "Spatial Sound-Field Reproduction by Wave-Field Synthesis," *Journal of the Audio Engineering Society*, vol. 43, no. 12, pp. 1003-1012, 1995.
- [20] A. N. Thiele, "Loudspeakers in Vented Boxes: Part 1," *Journal of the Audio Engineering Society*, vol. 19, pp. 382-392, 1971.
- [21] A. N. Thiele, "Loudspeakers in Vented Boxes: Part 2," *Journal of the Audio Engineering Society*, vol. 19, pp. 471-483, 1971.
- [22] R. H. Small, "Closed-Box Loudspeaker Systems—Part 1: Analysis," *Journal of the Audio Engineering Society*, vol. 20, pp. 798-808, 1972.
- [23] R. H. Small, "Closed-Box Loudspeaker Systems—Part 2: Synthesis," *Journal of the Audio Engineering Society*, vol. 21, pp. 11-18, 1973.
- [24] H. Tokuno, O. Kirkeby, P. A. Nelson and H. Hamada, "Inverse filter of sound reproduction systems using regularization," *IEICE Transactions on Fundamentals of Electronics, Communications and Computer Sciences*, Vols. E80-A, no. 5, pp. 809 - 820, 1997.
- [25] A. Farina, "Simultaneous measurement of impulse response and distortion with a swept-sine technique," *108th AES Convention*, 2000.



N. Rocchi received his B.S. and M.S. degrees (Cum Laude) in electronic engineering from University of Parma, Italy, in 2017 and 2019, respectively. He is currently a Ph.D. student of Information Technology at the University of Parma.

His main topics of interest are multichannel audio distribution, acquisition systems and audio amplifiers.



A. Toscani received the M.S. degree (Cum Laude) in electronic engineering and the Ph.D. degree in Information Technology from the University of Parma, Italy, in 2004 and 2008, respectively. Since 2004 he is employed in the Dept. of Information Engineering (now Dept. of Engineering and Architecture) at the University of Parma.

He is currently a Research Fellow, mainly focused on power electronics, high-performance electric drives, diagnostic techniques for industrial electric systems, and power converter for audio application. He is author of two patents.



L. Chiesi received B.S./M.S. degrees in Electronic Engineering from University of Parma in 2005/2009, then received Ph.D. in Industrial Engineering from the same university in 2016, with a thesis on microphone and loudspeaker array for room acoustic measurement. He was

research fellow of University of Parma acoustic group from 2013 to 2016 designing several microphone and loudspeaker arrays for audio recording and acoustic measurement application, as well as developing novel characterization and processing technique.

He is currently working in an industry that develops critical-asset condition monitoring systems, even based on vibration analysis. He is still supporting his former research group as external expert.



D. Pinardi received the M.S. degree (Cum Laude) in mechanical engineering from University of Parma, Italy, in July 2016, with a thesis on loudspeaker modelling. In March 2020, he got the Ph.D. degree in industrial engineering with a thesis on the design of microphone, hydrophone, and camera

arrays for spatial audio recording.

He is a research assistant of Prof. Angelo Farina from 2016, mainly specialized in spatial audio. Topics of his interest are design of sensors array, simulations and auralization, applied to automotive field and underwater acoustics.



M. Binelli received his B.S. and M.S. degrees in electronic engineering from University of Parma, Italy, in 2003 and 2006, respectively. He received his Ph.D. from University of Parma in 2010, with a thesis on analysis and equalization techniques in automotive acoustics.

Since 2010, he is employed as research assistant at University of Parma. His research topics are equalization, psychoacoustics, active noise control, microphones and loudspeakers arrays, virtual reality, and spatial audio.



A. Farina got his M.S. degree in civil engineering in December 1982 at the University of Bologna, Italy, with a thesis on the acoustics and vibrations inside a tractor cab. In 1987, he got a Ph.D. in Technical Physics at the University of Bologna with a thesis on experimental assessment of concert hall acoustics. He

was a full-time researcher since 1st November 1986 at the University of Bologna and since 1st March 1992 at the University of Parma. He became Associate Professor on 1st November 1998, and he is Full Professor of Environmental Applied Physics since 1st May 2005 at the University of Parma, where he has the chair of Applied Acoustics and Technical Physics.

During his academic career, Angelo worked in several fields of Applied Acoustics, including noise and vibration,

concert hall acoustics, simulation software and advanced measurement systems. In the last 10 years, he focused mostly on applications involving massive microphone and loudspeaker arrays. In 2008, Angelo Farina was awarded with the AES fellowship for his pioneering work on electroacoustic measurements based on exponential sine sweeps.

Angelo is author of more than 300 scientific papers and three widely employed software packages (Ramsete, Aurora Plugins, DISIA).



E. Bonomi received the B.S. degree in Civil Engineer from University of Trento in 2014. He has completed a master course in *Environmental and Industrial acoustics* at the University of Ferrara in 2016 and a master course in *Sound technology and music composition* at the University of Parma in 2019. The art studies are concluded in 2009 with a II lev. academic Diploma in Violin and a I lev. academic Diploma in Piano.

He worked from 2015 to 2019 as acoustic test manager in laboratories with ILAC-RMA accreditation. He is currently working in the power generation industry as acoustic engineer.



L. Tronchin is Associate Professor in Environmental Physics from the University of Bologna. He holds a M.S. degree in Building Engineering and a PhD in Applied Physics (Architectural Acoustics) from the University of Bologna. He has completed advanced courses on the Mechanics of Musical Instruments at CISM, Udine, Italy and on Noise and Vibration at the University of Southampton in the UK where he has also worked as a visiting researcher. He has held a post-Doctoral Scholarship in Room Acoustics.

A pianist himself, with a diploma in piano from the Conservatory of Reggio Emilia, Dr Tronchin's principal area of research has been musical acoustics and room acoustics. He is the author of more than 200 papers and was Chair of the Musical Acoustics Group of the Italian Association of Acoustics from 2000 to 2008. Dr Tronchin is President of Italian Section of AES.

Dr Tronchin is Associate Editor of the Journal of the Audio Engineering Society. General Chair of I3DA - Immersive and 3D Audio International Conference - 8-10 September 2021. He designed theatres and other buildings, as acoustic consultant, in collaboration with several Architects, among them Richard Meier and Paolo Portoghesi.